



Mercedes X-Class Wedgetail Fitting

INSTALLING RAILS AND ROOF RACK:

Congratulations on the purchase of your Australia made Wedgetail Roof Rack product, please follow these instructions to ensure correct fitment.

The photos below indicate the method to create a pocket in the mastic roof joint to allow Wedgetail rail mounting lugs to be riveted in place.

1. Apply masking tape as shown to avoid any damage to vehicle paintwork whilst you are working
2. From the windscreen mark a centre point at 335mm and 1140mm using tape measure.

This will mark the central point for the Wedgetail mounting lugs provided

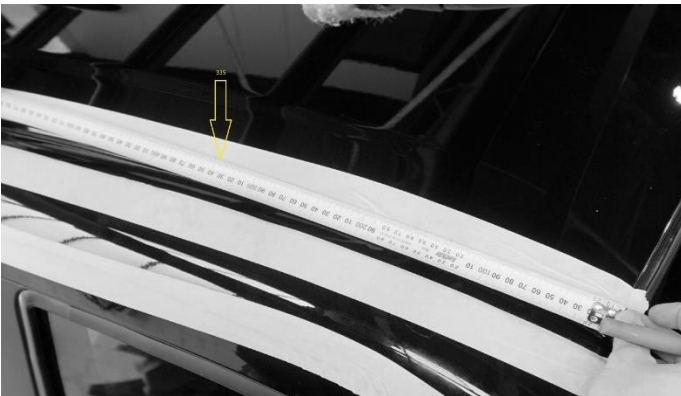

3. Mark the positions with grey lead or whiteboard marker prior to removal of mastic to mount lug

Warning: double check to ensure you have correctly marked the mounting position to correspond with where you wish the Wedgetail Platform to be positioned on the roof.



4. With a sharp knife score the vehicle paintwork either side of the mounting lug and cut down into the mastic to create a neat slot as shown in the following pictures



5. Place the Lug in the hole and Drill 4 holes using 5mm drill

***Warning ensure you use a drill sleeve so as not to damage interior lining wiring or curtain airbags**

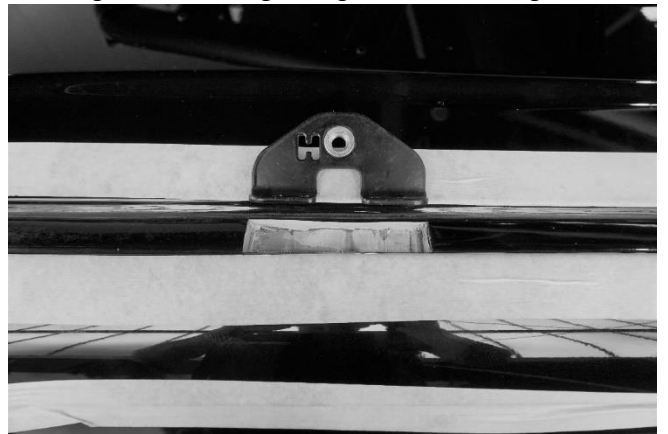

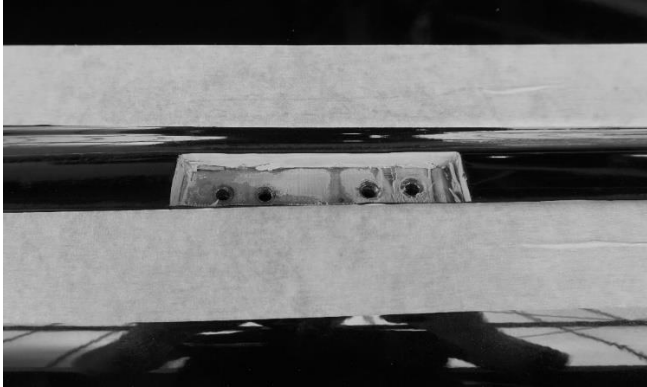

6. Apply silicone or similar urethane sealant to the drilled holes.
7. Attach lugs and cover plates to the roof of vehicle using 5mm Rivets provided.

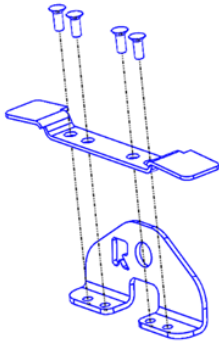

This fitment uses Structural Non-Sealed rivets for strengthening reasons

Silicon must be applied to the top of the rivet to prevent water ingress.

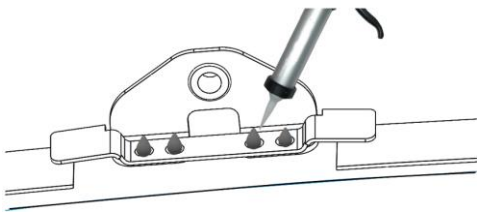

8. Attach Rails to lugs using 10mm hardware with the wedgetail logo facing to the front of the vehicle. Refer to the pictures provided here. Do not fully tighten

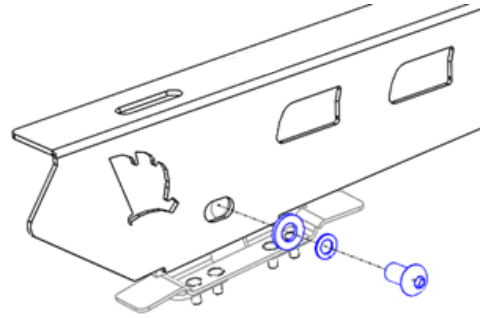

9. Fit 10mm Bolt / Flat washer / Split washer / Strut Nuts to the top of rail.
**strut nuts to the top as shown in the diagram below*

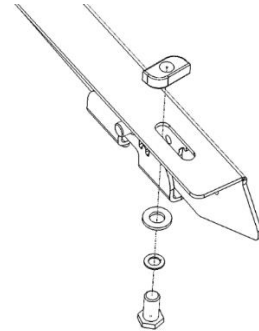

10. Place the Wedgetail Platform on the rail. Do not tighten fully.
11. Centralize the rack side to side on the wedgetail rails.
12. Fully tighten remaining bolts in the following order:
 - a) Rail to the Lug
 - b) Rails to Platform** ensure to push strut nut up and turn 90 degrees in platform crossbar channel to secure*

Check fastenings are firmly tensioned at regular intervals
Do not overtighten so as to preserve spring washers.

Thank you for your purchase

Please complete your warranty application following correct installation

Wedgetail by Tradesman Roof Racks

Innovation through Inspiration